

Package Dimensions:

Directivity

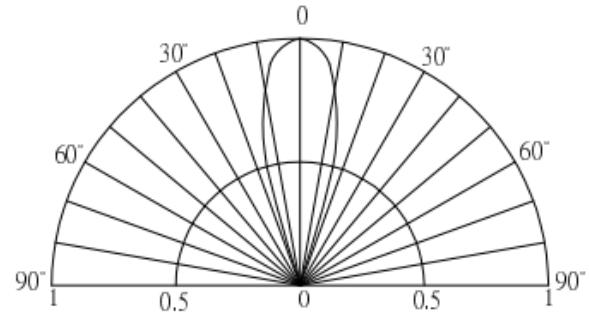
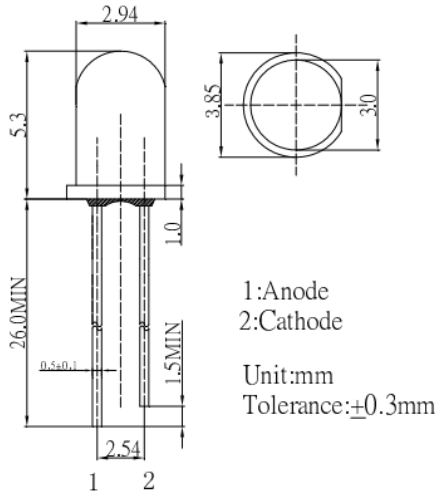

Electrical –Optical Characteristics (Ta=25°C)

Item	Symbol	Condition	Min.	Typ.	Max.	Unit
DC Forward Voltage	VF	IF=20mA	1.80	2.10	2.40	V
DC Reverse Current	IR	VR=5V	-	-	10	µA
Domi. Wavelength*	λd	IF=20mA	620	625	630	nm
Luminous Intensity*	IV	IF=20mA	750	1120	-	mcd
50% Power Angle	2θ1/2	IF=20mA	-	30	-	deg

*1 Tolerance of dominant wavelength is ±1nm

*2 Tolerance of luminous intensity is ± 15%

Absolute Maximum Rating (Ta=25°C)

Item	Symbol	Value	Unit
DC Forward Current	IF	30	mA
Pulse Forward Current*	IFP	100	mA
Reverse Voltage	VR	5	V
Power Dissipation	PD	72	mW
Operating Temperature	Topr	-30 ~ +85	°C
Storage Temperature	Tstg	-40 ~ +100	°C
Lead Soldering Temperature	Tsol	260°C / 5sec	-

*Pulse width max.10ms, Duty ratio max 1/10