

Features

- Package (L/W/H): 3.2 x 1.6 x 0.9mm
- Color: Ultra Bright White
- Lens: Water Clear Flat Mold
- EIA STD Package
- Meet ROHS, Green Product
- Compatible with SMD Automatic Equipment
- Compatible with infrared reflow solder and wave solder process

Package Profile & Soldering PAD Suggested

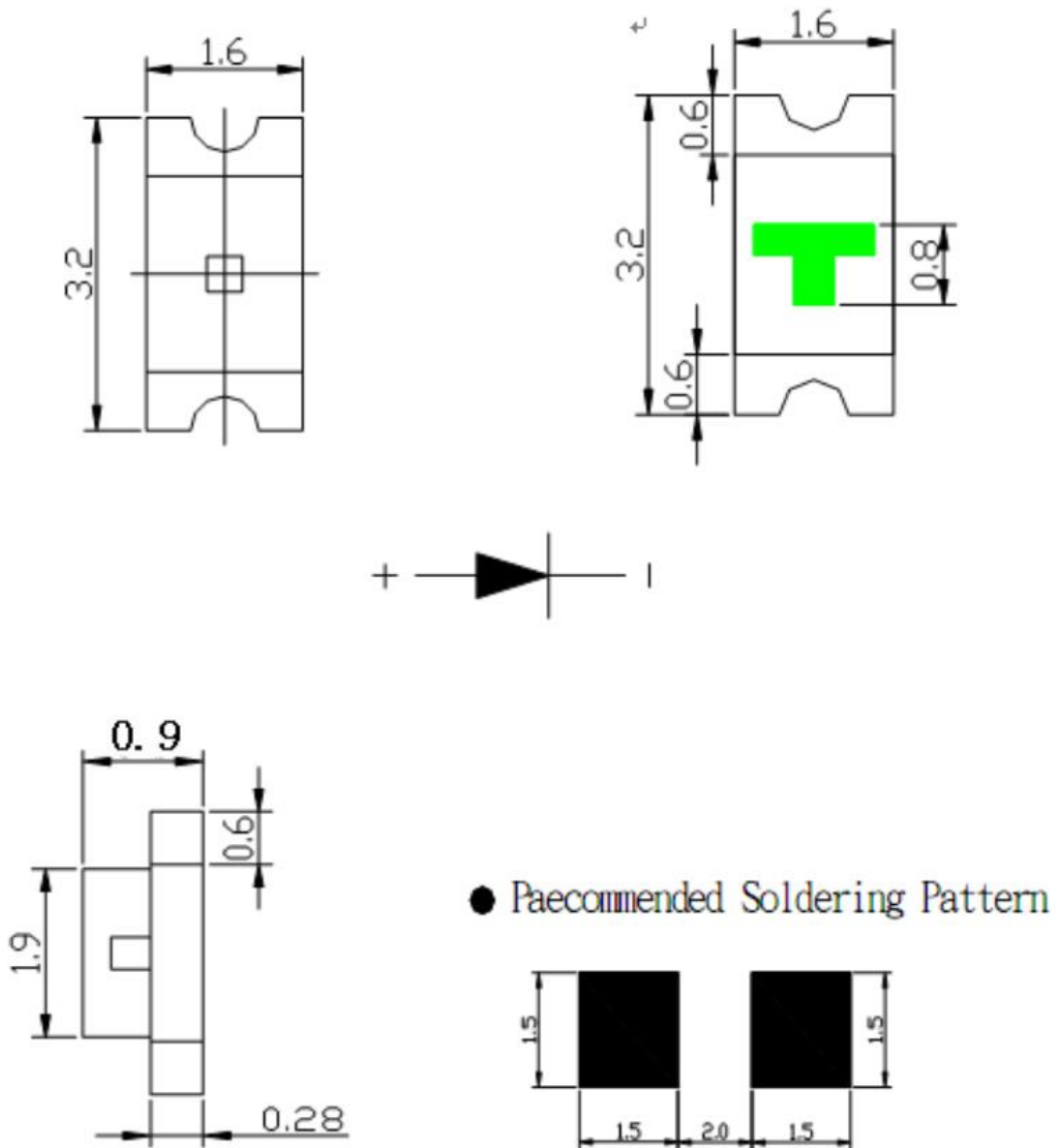

Notes:

All dimensions are in millimeters;
Tolerance is ± 0.10 mm unless otherwise noted

Soldering Profile Suggested

For Lead Solder

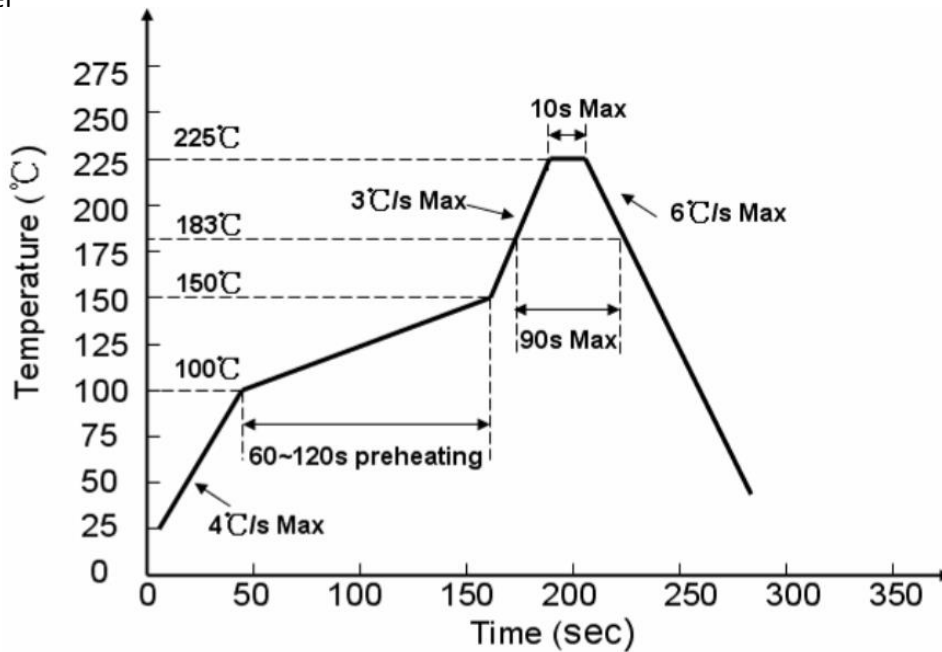

For Lead Free Solder

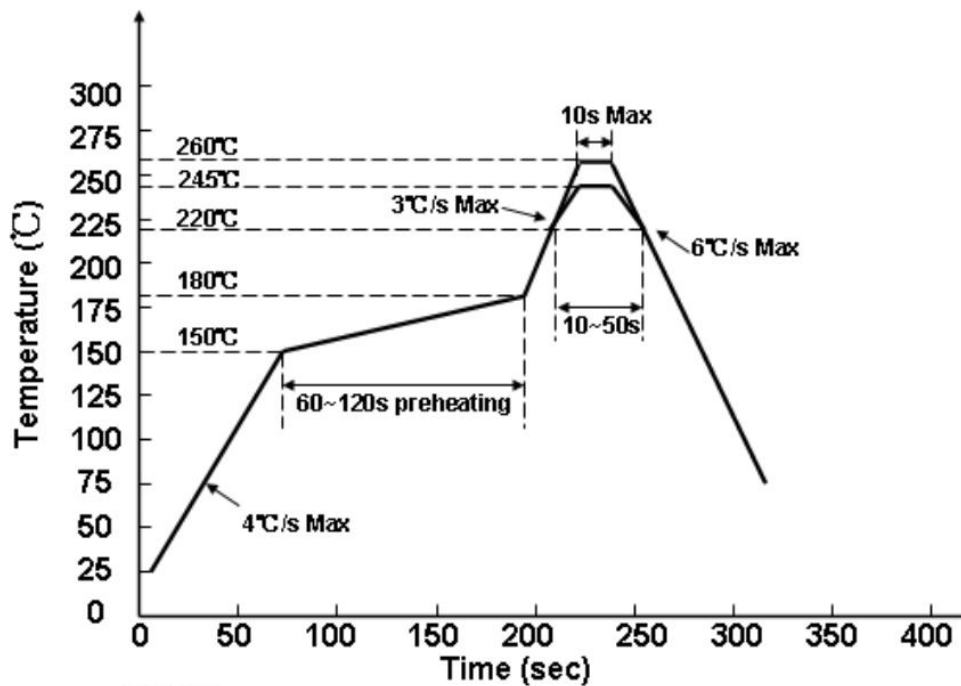

Notes:

We recommend the soldering temperature $245 \pm 5^\circ\text{C}$;

The maximum temperature should be limited to 260°C .

Absolute Maximum Ratings at Ta=25°C

Parameter	Symbol	Rating	Unit
Power Dissipation	Pd	90	mW
Peak Forward Current (1/10 Duty Cycle, 0.1ms Pulse Width)	IFP	100	mA
DC Forward Current	IF	30	mA
Reverse Voltage	VR	5	V
Operating Temperature Range	Topr	-30°C ~ + 85°C	
Storage Temperature Rang	Tstg	-40°C ~ + 90°C	
Soldering Condition	Tsol	Reflow soldering : 260°C For 5 Seconds Hand soldering: 300°C For 3 Seconds	

Electrical Optical Characteristics at Ta=25°C

Parameter	Symbol	Min.	Typ.	Max.	Unit	Test Condition
Luminous Intensity	IV	--	450	--	mcd	IF=20mA
Viewing Angle	2θ1/2	--	120	--	deg	IF=20mA
CIE 1931 Coordinate	X	--	0.28	--		IF=20mA
	Y	--	0.27	--		
Spectral Line Half-Width	Δλ	--	35	--	nm	IF=20mA
Forward Voltage	VF	2.8	--	3.4	V	IF=20mA
Reverse Current	IR	--	--	10	uA	VR=5V

Notes:

1. Luminous intensity is measured with a light sensor and filter combination that approximates the CIE eye-response curve
2. θ1/2 is the off-axis angle at which the luminous intensity is half the axial luminous intensity
3. The dominant wavelength, λd is derived from the CIE chromaticity diagram and represents the Single wavelength which defines the color of the device.

Typical Electrical-Optical Characteristics Curves

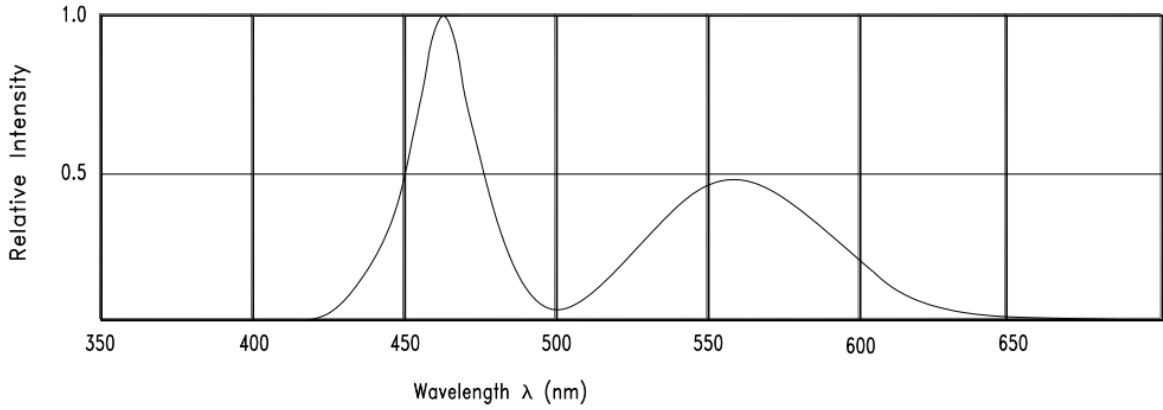

Fig.1 Relative Intensity vs. Wavelength

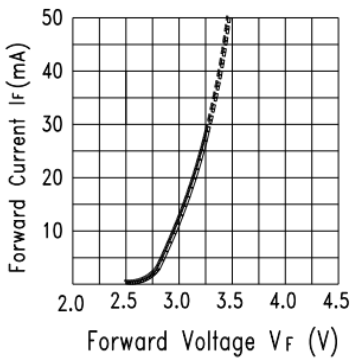

Fig.2 Forward Current vs. Forward Voltage

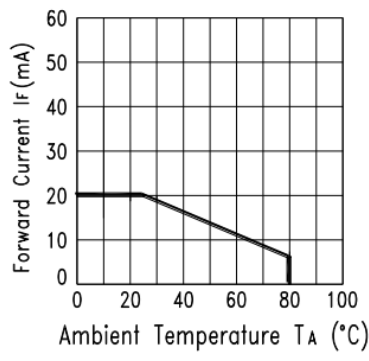

Fig.3 Forward Current Derating Curve

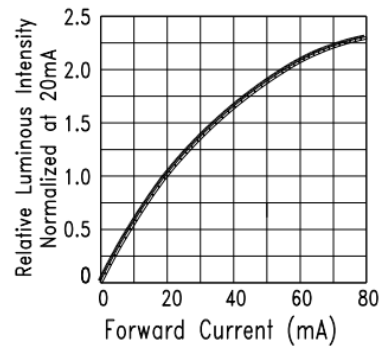

Fig.4 Relative Luminous Intensity vs. Forward Current

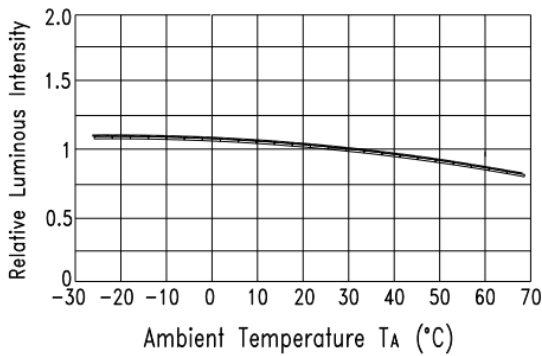

Fig.5 Luminous Intensity vs. Ambient Temperature

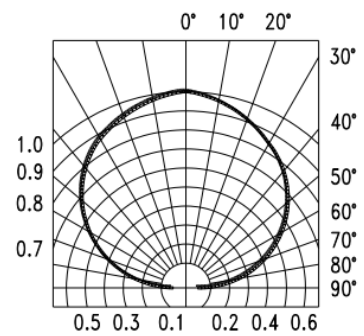
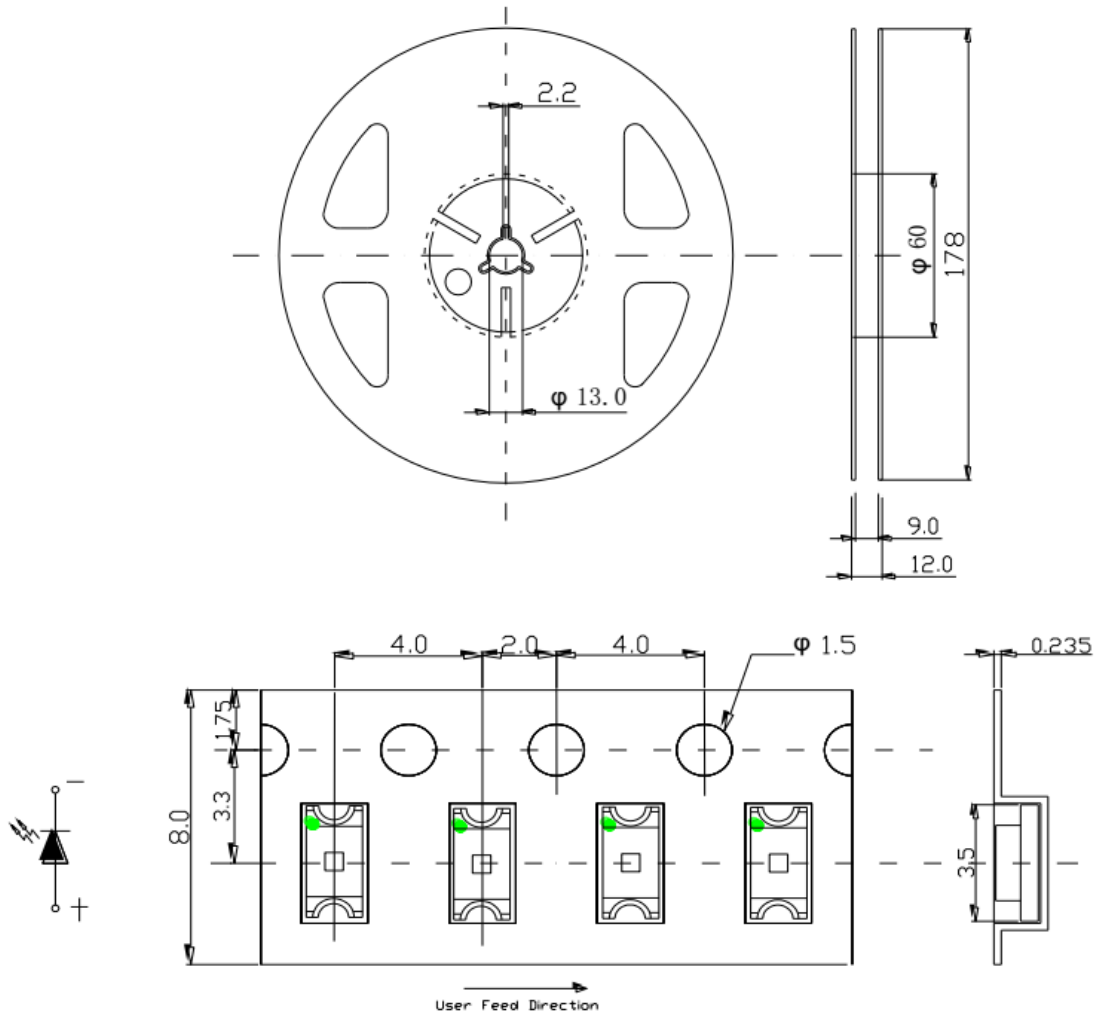

Fig.6 Spatial Distribution

Reel and Tape Dimensions



Tape Leader & Trailer Dimensions and Reel

